



PlayStation

®

NTSC U/C

®

PlayStation

DRIVER™

YOU ARE THE WHEELMAN™

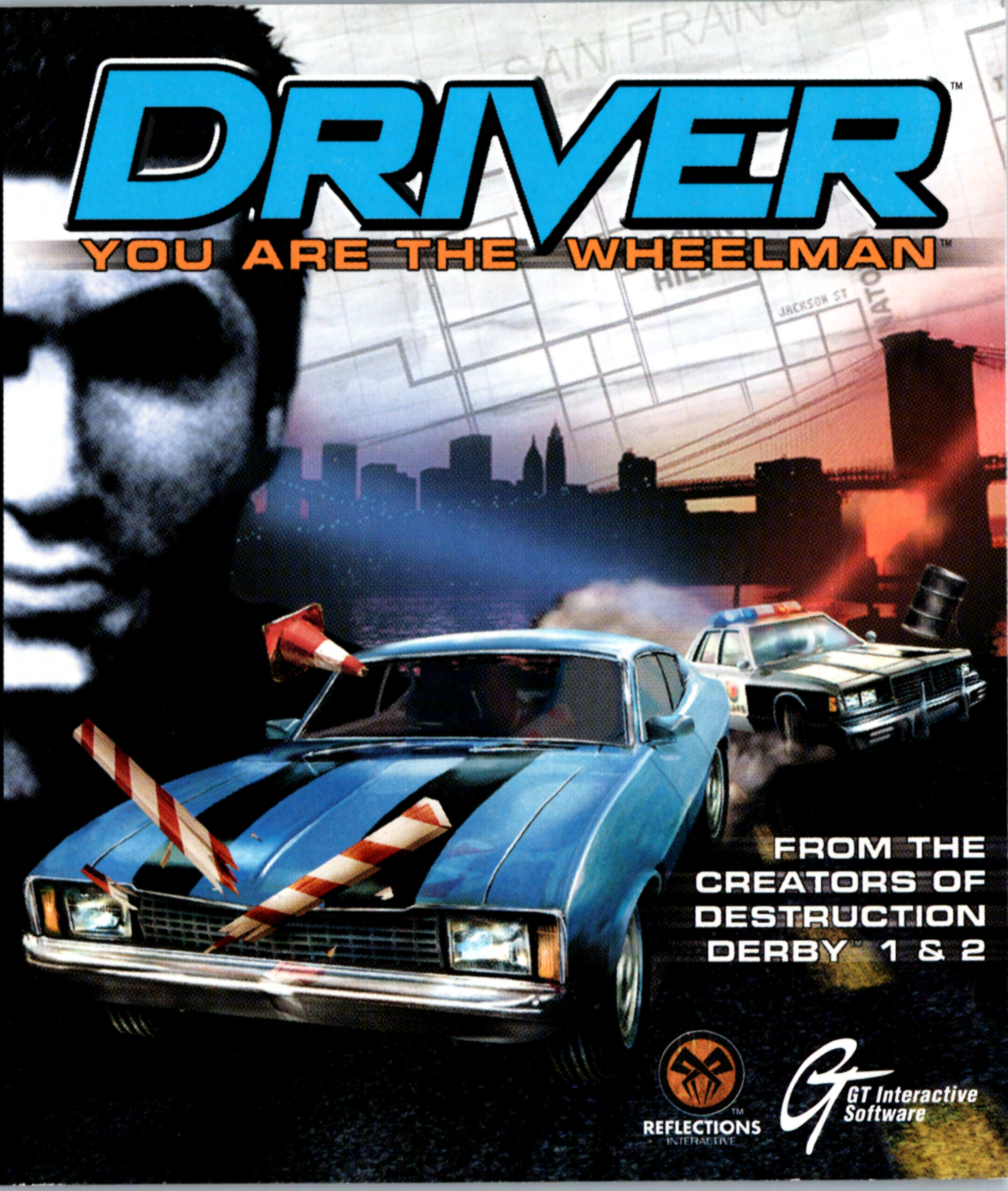

FROM THE
CREATORS OF
DESTRUCTION
DERBY™ 1 & 2



CONTENT RATED BY
ESRB

SLUS-00842
04-18112



REFLECTIONS
INTERACTIVE



GT Interactive
Software

WARNING Read before using your PlayStation® game console.

A very small percentage of individuals may experience epileptic seizures when exposed to certain light patterns or flashing lights. Exposure to certain patterns or backgrounds on a television screen or while playing video games, including games played on the PlayStation® game console, may induce an epileptic seizure in these individuals. Certain conditions may induce previously undetected epileptic symptoms even in persons who have no history of prior seizures or epilepsy. If you, or anyone in your family, has an epileptic condition, consult your physician prior to playing. If you experience any of the following symptoms while playing a video game - dizziness, altered vision, eye or muscle twitches, loss of awareness, disorientation, any involuntary movement, or convulsions - IMMEDIATELY discontinue use and consult your physician before resuming play.

Warning to owners of projection televisions:

Do not connect your PlayStation® game console to a projection TV without first consulting the user manual for your projection TV, unless it is of the LCD type. Otherwise, it may permanently damage your TV screen.

Handling your PlayStation® Disc

- This compact disc is intended for use with the PlayStation® game console.
- Do not bend it, crush it or submerge it in liquids.
- Do not leave it in direct sunlight or near a radiator or other source of heat.
- Be sure to take an occasional rest break during extended play.
- Keep this compact disc clean. Always hold the disc by the edges and keep it in its protective case when not in use. Clean the disc with a lint-free, soft, dry cloth, wiping in straight lines from center to outer edge. Never use solvents or abrasive cleaners.

TABLE OF CONTENTS

GETTING STARTED2
CONTROLLING THE CAR4
THE STORY6
MAIN MENU6
TRAINING15
FILM DIRECTOR17

GETTING STARTED

1. Set up your PlayStation® game console according to the instructions in its Instruction Manual.
2. Make sure the power is off before inserting or removing a compact disc.
3. Insert the Driver™ disc and close the disc cover.
4. Insert game controllers and turn on the PlayStation® game console. Follow on-screen instructions to start a game.

Console

Top View

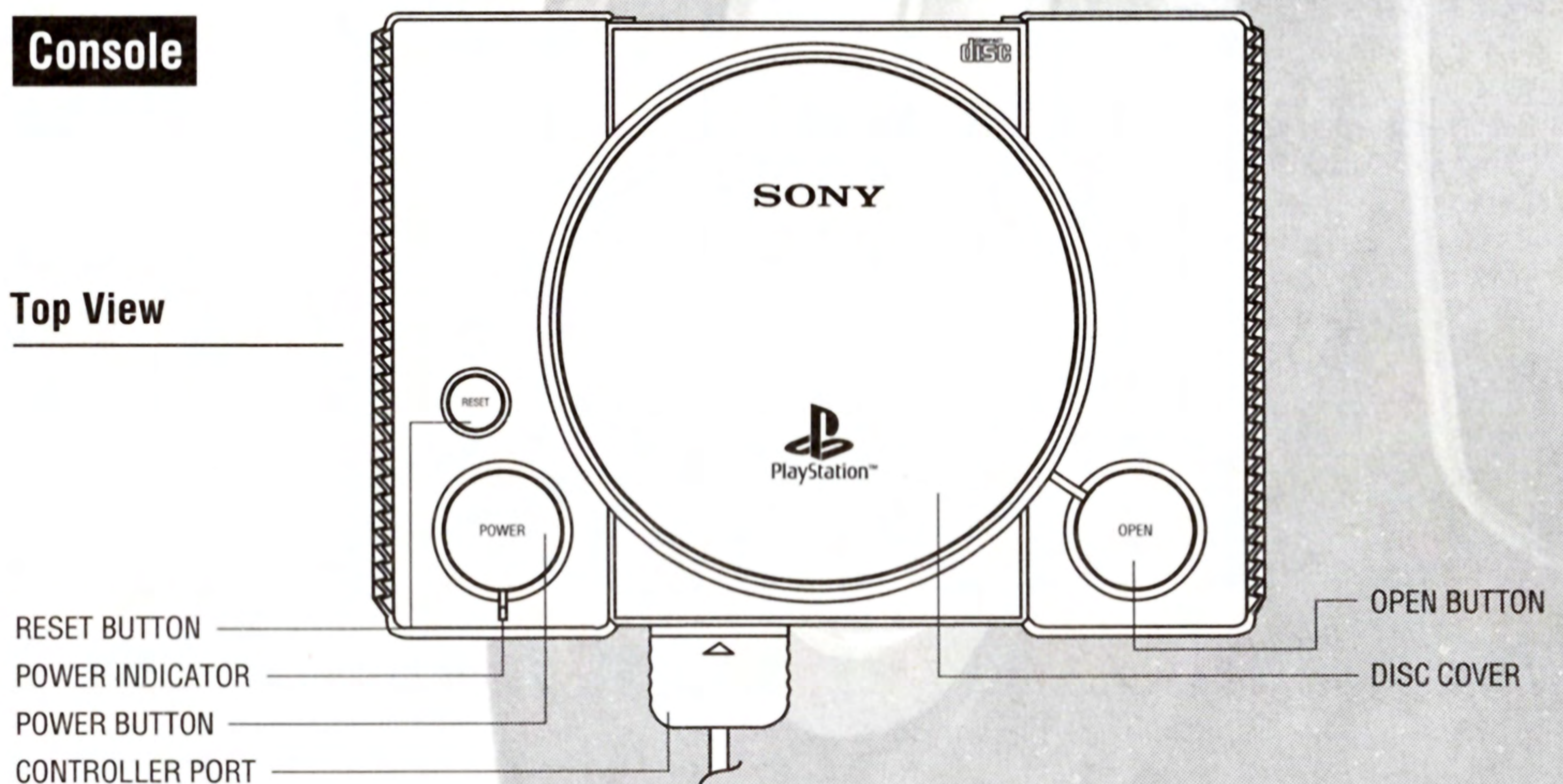

Front View

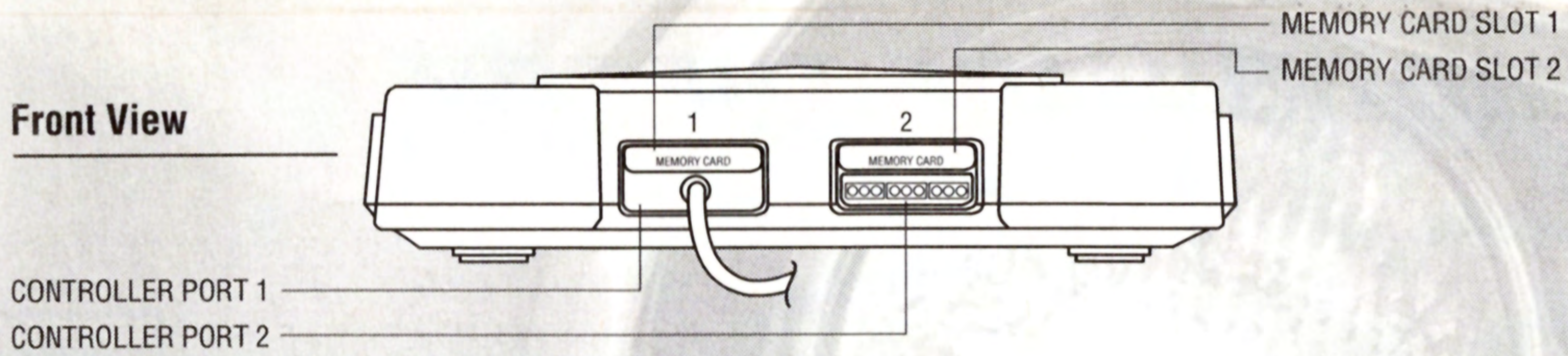

Controller

Front View

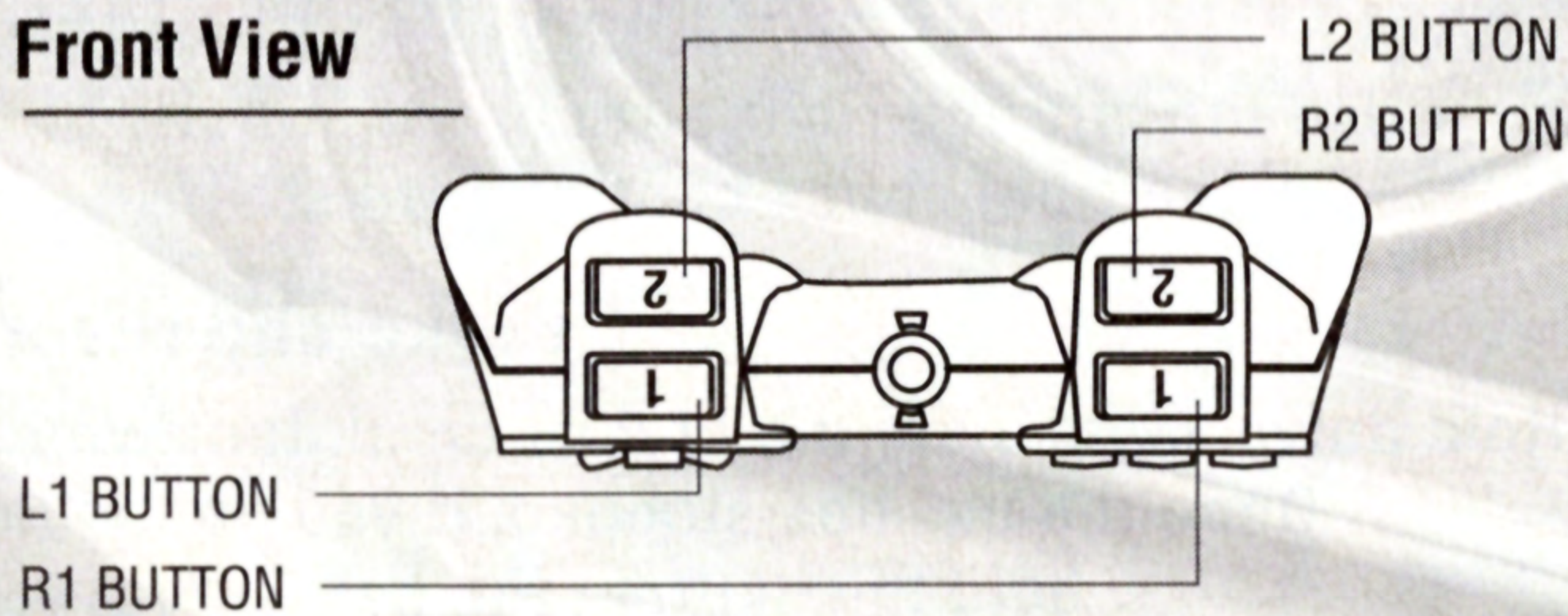

Top View

Dual Shock™
analog controller

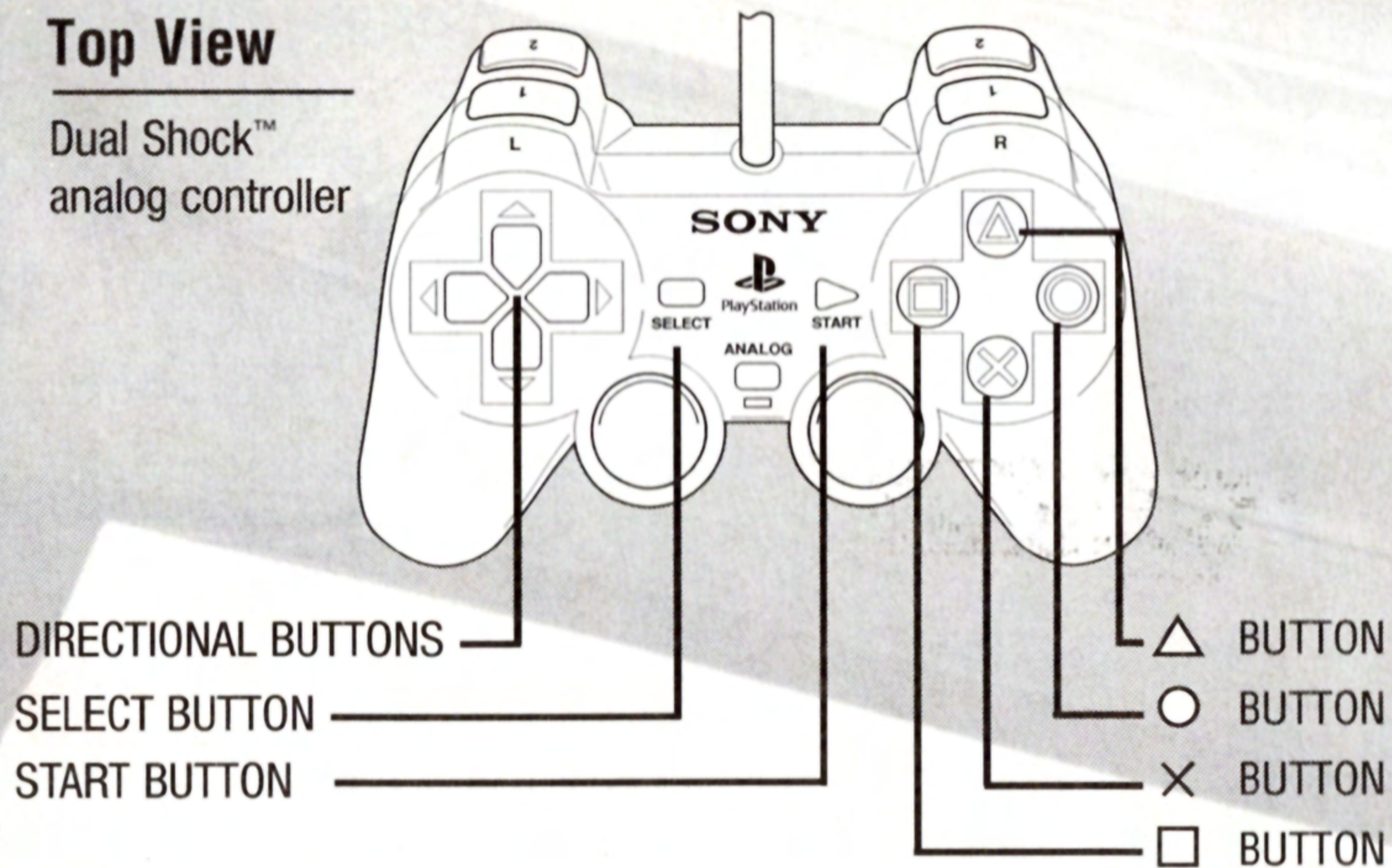

CONTROLLING THE CAR

Accelerate

Use ⊗ to accelerate the car.



Directional Pad / Analog Dual-shock Controller Steering

Use the left and right directional buttons or the Analog Dual shock controller to steer the car.



Brake and reverse

Hold down ◻ to slam the brakes on all four wheels. Once the car has stopped, if you continue to hold this button, the car will reverse.



Pull handbrake

Hitting △ will yank the handbrake and lock the rear wheels. Use the handbrake to throw the car into tight bends, or to spin 180°. (Note that the car automatically locks the rear wheels in fast turns; see the Options section to turn automatic braking off).



Burnout

Floor it and smoke the back wheels. Use the burnout for dragster style getaways or to get out of tight spots when the Cops corner you.



Max Steer Lock

Holding L1 will instantly turn the steering wheel all the way in the direction you are turning. Use it for over-steer correction.



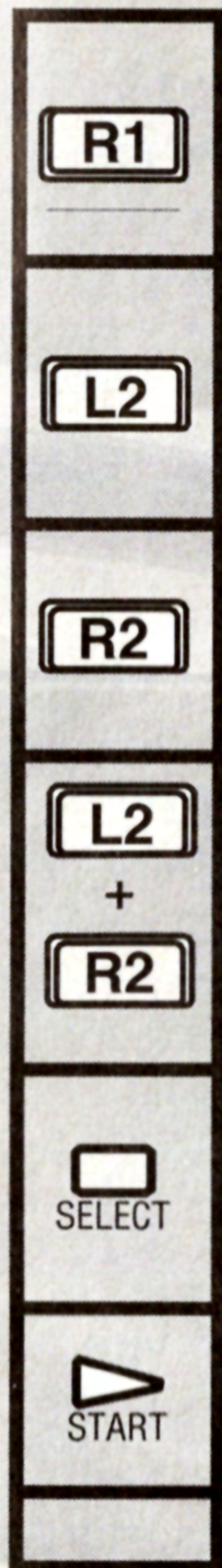

Horn

Blast the horn to terrorize pedestrians on the sidewalks and in the café bars

Look Left

Hold L2 to look left. Try looking as you drive through crossroads, or when you're looking out for the cops.

Look Right

Hold R2 to look right. Try looking as you drive through crossroads, or when you're looking out for the cops.

Look Behind

Essentially your rear view mirror, hold both L2 and R2 to look behind you. When the cops are on your tail you need to know exactly where they are and what their next move could be.

Switch camera view

Hitting select will cycle the camera view through 3 different perspectives.

Pause the game

The Start button will pause the action.

Dual Shock

If you have an analog dual-shock controller inserted it will vibrate when you are spotted by a vigilant Cop, when you collide with an object or drive on rough terrain.

THE STORY

Your name is Tanner. A few years back you left professional stock car racing for police work. Now you're going undercover to infiltrate the underworld's most powerful, most dangerous organization: the Castaldi family. You've turned in your badge and left New York for Miami, where your first contact awaits. Watch your back, Tanner; when you're in this deep, you don't know who you can trust.

MAIN MENU

Once the animated introduction has finished the game will take you to the Main Menu. Here you'll find game options and various games for you to play. Move the directional buttons from left to right to highlight your choice and hit ⊗ to select. Following is a list of the different types of games and game options. Undercover is the main game, but try the Training section first to help you develop your driving skills and practice for your first mission.

UNDERCOVER

NEW GAME

Selecting New Game will take you to a disused multi-story parking garage where you get the chance to show off your driving skills to your potential employers in the underworld's version of an interview. If you pass the tests in the allotted time you will go undercover, driving missions for Castaldi and his minions in four cities, starting in Miami. Later missions will take you to San Francisco, Los Angeles and New York. If you're having trouble passing the interview, select the Training section from the Main Menu to see an example of how it's done.

LOAD A SAVED GAME

This enters the memory card manager screen; from here you can load your saved games. Once you've loaded your game you'll be taken directly to the motel room in the city where you last saved.

THE INTERVIEW

In the parking garage interview you'll see the following display:

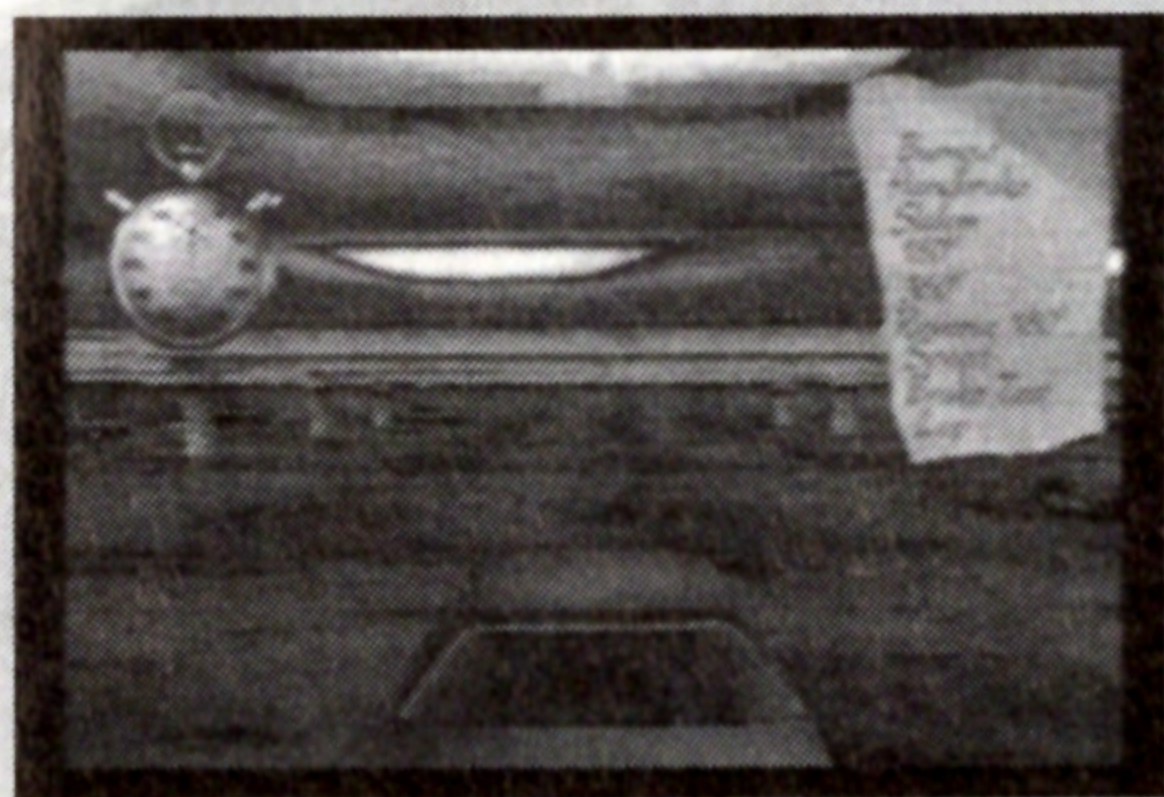

In the top left you'll see a stopwatch marked at 60 seconds; this indicates the amount of time you have left to complete all the maneuvers listed on the top right of the screen. When time is almost up, the stopwatch will begin to flash red as a reminder to put your foot down if you want the job.

At the top right of the screen is a list of driving maneuvers you have to complete in the allotted time. If you haven't been to the Training garage first, you may struggle with some of the more complicated moves. (See Training below)

Once you successfully complete a move, a red line will cross it off the list. But it's not just the maneuvers you have to worry about; there are a number of parked vehicles in the garage to make life a little more difficult.

Each time you scratch the paint job - whether you hit another vehicle, a wall or a pillar - a red X will appear at the top of the list. If you get four X's, the interview is over and you'll have to try again.

If you manage to complete all the moves in time, the job's yours and you'll move on to the first motel room, located somewhere in Miami.

IN THE MOTEL ROOMS

When you're up against some of the toughest gangsters and hoods around it's a good idea to keep a low profile. After your interview with the Castaldis, you'll return to your motel room. You're not staying at five star resorts, but at least these places are safe. Listed below are the items you'll find in the rooms and their uses.

Move the directional buttons from left to right to move from location to location.

IN THE MOTEL ROOMS (CONT.)

SAVE GAME

At various points throughout the missions you'll be able to save your progress. Selecting the VCR will take you to the memory card manager. From here you can save your game in a free space or write over any of your previous save games.

GET A NEW JOB

Messages on the answering machine are your mission choices, left by clients while you've been out burning rubber on previous missions. The icons from left to right represent:

- Hear previous message
- Play current message
- Hear next message
- Accept mission

Selecting Accept current mission will launch the mission described in the current message.

OPTIONS

From the options toolbox you can adjust the following settings:

- Music Volume
- SFX Volume
- Auto Handbrake
- Vibration

TAKE A DRIVE

Take a ride around the city where you currently reside. There's no better way to acquaint you with the streets, shortcuts, hiding places and alleyways.

QUIT BACK TO TITLE SCREEN

Quit your current game and return to the main menu.

ON THE ROAD

When you're playing the game in the cities, the following items indicate your progress, position and status.



TIMER

The timer at the top center of the screen indicates your current mission time. The timer counts down for some missions, and up for other missions. Sometimes you'll have to reach checkpoints to add more seconds to your available mission time.

DAMAGE

Every time you hit a building, wall, solid object, or vehicle your car takes some damage. The severity of the damage depends on the severity of the crash. Once the damage bar becomes full your car is wrecked and it's Game Over. If at any time you flip onto your roof or side, your damage level will increase to maximum and the mission will be over.

FELONY

Your Felony bar increases when you commit a crime (like speeding or reckless driving) in a Cop's field of view (This is explained under the Radar heading below). Once the Cop chase ensues his aggression level will increase along with your rising felony rating.

RADAR

The radar indicates your position in the city, your objectives and - most importantly - the Cops. Cops are shown as white dots with a field of vision cone, which indicates their direction and range of vision. If you commit a felony within a cop's field of vision cone, he'll give chase and alert HQ, who will dispatch more anxious Cops determined to stop you in your tracks. At this time their vigilance increases and their range of vision expands. When you're being pursued the radar will flash red and blue. When you successfully lose your pursuers, the radar will return to its usual color.

Your mission objective or waypoint is also marked on the map. The cities in Driver are enormous so you can't always see your objective on the radar (you can find your objective by pressing Pause and selecting Show Map.). However, a large triangular black "arrow" does appear on your radar, pointing at your objective or waypoint. As you get nearer to the objective the arrow will begin to narrow. The closer you get, the narrower the arrow becomes, until the objective comes into view on the radar and is marked as a flashing white dot.

COP LOCATION ARROWS

If the Cops spot you committing a felony, they'll initiate a chase. Press the L2 and R2 buttons simultaneously to look behind you and see where they are, but this isn't always a good idea if you're making your way through busy rush hour traffic. Each red arrow at the bottom of the screen gives you an instant indication of each pursuing Cop's position. If the red arrows are transparent this means the Cops are in pursuit but some distance away. Once the Cops get right on your tail the arrow will become a deep red. The number of arrows shows how many are in pursuit.

During the in-game sections you will come across the following menus.

PAUSE MENU

Continue	Continue with your mission
Restart	Begin the mission again
SFX Volume	Adjust Sound Effects level
Music Volume	Adjust Music level
Film Director	Move to replay editor
Quick Replay	Show an Auto Director replay
Show Map	Show an overhead map. Indicating your position in the city, a white pulsing dot, and your next objective, a red pulsing dot
Exit	Quit to Main menu

MISSION OVER

Film Director	Move to replay editor
Quick Replay	Show Auto Director replay
Save Replay	Save your replay with the Memory card manager
Save Game	Save your game with the Memory card manager
Continue	Continue with next mission
Exit	Quit to main menu

MISSION FAILED

Film Director	Move to replay editor
Quick Replay	Show an Auto Director replay
Save Replay	Save your replay with the Memory card manager
Try Again	Attempt the mission / game again.
Exit	Quit to main menu

HIGH SCORES

Your success during the various driving games can be recorded here in the Hi-Scores section.

VIEW TABLES

Tables are listed separately under the following headings:

Checkpoint
Trailblazer
Survival
Dirt Track

LOAD HI-SCORES

Load any previously saved Hi-Score tables.

SAVE HI-SCORES

Save your current Hi-Score tables to memory card.

OPTIONS

The Options menu allows you to change the following settings.

SOUND

Music Volume

Adjust the slider to increase or decrease the volume.

Effects Volume

Adjust the slider to increase or decrease the volume.
Hit X to test the sound effects level.

Accept Changes

GAMEPLAY

The Gameplay options menu allows you to change the following options:

Cop Difficulty

Easy/Med/Hard

Changing the Cop Difficulty will affect the overall driving ability and effectiveness of the Police forces across all Undercover missions and driving games.

Auto Handbrake

On/Off

Turning the Auto hand brake on or off will affect the overall handling of the car throughout the game. The game defaults to Auto Handbrake On. This gives the car the tendency to over-steer into corners; the sharper you turn into the corner the more you'll notice the over-steer and eventual spin.

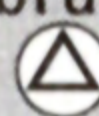
Auto Handbrake Off causes the car to under-steer into corners, and you'll have to use the handbrake  to make the turn successfully and carry through your entry speed as you correct the steering and continue on your way.

Vibration

On/Off

If you have an Analog Dual Shock controller inserted this option will allow you to turn the vibration on or off.

Accept Changes

VIEW CONTROLS

This option will display the controller and the position and function of each of the buttons.

CENTER SCREEN

If the image on your screen is off-center, select this option to adjust it. Use the directional buttons to move the screen up, down, left or right. Press X to save the new screen position.

TAKE A RIDE

Take A Ride lets you take a free drive through any one of the four cities in Driver. At the beginning of the game you'll be able to take a ride through the streets of Miami and San Francisco. You can take a ride through Los Angeles and New York once you have reached them in the Undercover section of the game.

When you select the city you want to drive through you will then be asked if you want to drive at night or during the day (except in Los Angeles, where all the drives and missions take place at night).

DRIVING GAMES

You can partake in any of the driving games from this menu. After you select a game you will then be asked which city or level you would like to play. At the beginning of the game you'll be able to play the game across the streets of Miami and San Francisco. You can play through Los Angeles and New York once you have reached them in the Undercover section of the game.

PURSUIT

Start by choosing a city; you can select any city you've reached in the Undercover section of the game. Once you start you'll have to chase and crash into the lead car as it tries to out-maneuver, out-brake and out-wit you across the streets, parks and alleyways.

GETAWAY

At the start of each Getaway game the Cops are on your tail immediately. You must lose them by any means necessary. The quicker you lose the Cops the better.

CROSS-TOWN CHECKPOINT

First select the city you want to race across. Once the game starts you'll have to race from checkpoint to checkpoint in the fastest time possible. The checkpoints

are shown on the radar. Once you successfully reach the first one, the second one will be shown on the map, and so on until you complete the level. The faster the time, the better. There are two Checkpoint games in each city.

TRAIL BLAZER

Hit as many markers as possible, and finish fast. Your finishing time will be affected by the number of markers touched, one second added per cone. The higher the time, the better. Once you've completed the course hitting all the markers, go for it again to try and improve your time. There are two Trail Blazer games in each city.

SURVIVAL

How long can you survive against a barrage of veteran Cops, hell-bent on taking you in, whatever the financial cost of replacing damaged Cop cars? The idea is to survive as long as possible; the longer you survive the better.

DIRT TRACK

Follow the circuit through the cones, across the slippery desert dust, weaving in and out of the buildings and fences. You'll be penalized for knocking over cones and seconds will be added to your overall finishing time. You will also be penalized for driving outside the marked circuit and missing the course checkpoints.

Practice

Practice on the dirt track of your choice; it's an ideal way to get used to controlling and maneuvering the car in tricky, tight and slippery surroundings. Once you complete a lap you will be joined by a "glass" car, which represents your best lap in this session. This will give you the perfect visual indication of your progress - or regress.

Time Trial

Choose one of the Dirt Track courses and go for your best time over a set number of laps. There is no "glass" car this time; just go out on the track and set the best time. There is an on-screen representation of your progress.

CHEATS

Once you complete the final mission of the game, you will be rewarded with secret cheat codes. Once they're unlocked, you can enter them here.

TRAINING

CAR PARK

Watch the demonstration car as it shows all the routes and maneuvers you'll need to master before moving on to the undercover story line and missions, by passing the parking garage interview. Positioned at the top right of the screen is a graphic displaying the Playstation Controller. As the demonstration car performs its maneuvers, watch the key presses and movements indicated on the controller. At any time you can quit the demonstration by pressing Start and selecting "Try it" from the menu; this time it'll be you in control of the car.

Burnout

Use the  button to smoke the back tires.

Handbrake

To pass this test simply accelerate forward and press the  button to wrench the handbrake.

Slalom

Watch the demonstration car closely as it weaves through the concrete pillars in a continuous figure-eight motion. Complete a full slalom of one row of pillars to pass this move.

180

Accelerate forward, wrench the hand brake and hold it while steering left or right until the car has completed a 180° spin.

360

Accelerate forward using the burnout button . Steer left or right and control the car as it spins in a "doughnut." Hold the burnout until the car spins through 360°.

Reverse 180

Hold the brake/reverse button , and as the car gathers speed in reverse, wait for the engine revs to peak then release the reverse button while turning left or right. Hold the steering until the car spins through 180° and settles facing the right way.

Speed

Find enough room to pick up speed in a straight line, set off at full acceleration and don't let off the gas until a red line appears through "Speed" - or until your nerve goes.

Brake Test

Brake test the car by driving as fast as you dare towards a wall or parked vehicle, leaving your braking until the last minute.

Lap

Again, watch the demonstration car as it performs a lap of the parking garage. Drive around the outside of the pillars, taking care not to smash into them, the walls or parked cars. If you complete a full lap of the parking garage unscathed you're through.

THE DESERT

More open training through a number of dirt tracks, circuits and slaloms across a number of different surfaces. Positioned at the top right of the screen is a graphic displaying the Playstation Controller. As the demonstration car performs its maneuvers, watch the button presses and movements on the controller.

Once you've watched the "glass" car make its way across the course you can move onto the Desert and try it for yourself. To stop the demonstration at any time press the Start button.

Don't let the "glass" car get too far ahead of you, or you'll have to start over. Also, hitting cones or other obstacles will result in penalties.

PAUSE MENU

Continue

Continue Demonstration

SFX Volume

Adjust sound effects level

Music Volume

Adjust music level

Exit

Quit to main menu

DEMO OVER

See it again

Try it

Exit

Re-start demonstration

Have a go yourself

Quit to main menu

CAR CHASES



The Film Director section of Driver is essentially your own director's editing suite where you can view your pre-saved replays or follow the instructions below to edit every camera type, timing and position to create a car chase movie of your very own.

LOAD FILM REPLAYS

This takes you to the Memory Card Manager where you can load any of your pre-saved replays. Once loaded you'll be taken straight to the Film Director where you can begin editing your own car chase movies.

PLAY CHASE 1-4

There are four example car chase movies on the Driver disc, recorded and edited by the Reflections team. You can either watch these as great examples of what can be achieved with a little time and patience with the Film Director.

FILM DIRECTOR

Using the intuitive icon set across the top of the screen you'll be able to place cameras wherever you want them. Zoom in on the action, attach cameras to cars, position cameras to follow your car, place static cameras to watch the action fly by or simply sit back and let the game do all this for you with the Auto Director. The choice is yours.

The colored bar across the top of the screen scrolls along from right to left when you hit the play button, start the Auto Director, fast forward or frame advance. The black line in the middle of the bar represents the replay's current position. The color of the bar changes and corresponds to each specific camera type. They are as follows:

Chase Camera	Red
Fixed camera (Zoomed)	Green
Fixed camera (No Zoom)	Yellow
In-Car (Player)	Dark Blue
In-Car (Pursuer)	Light Blue



When the new color / camera reaches the black marker the camera perspective and type will change.

Beneath the bar (from left to right) the icons shown represent the functions listed in more detail below.

Hit  to select all of the icons from the menus and sub-menus. Whenever you make any changes to the camera positions, locations and types, the Film Director will give you the option of trying camera angles before you put them in place. You can do this from the camera sub menus detailed below. If you're happy with the new camera status, you must always select the OK icon in that specific sub-menu to implement the change in your replay. Without hitting OK, the camera choices and selections will be cancelled and the replay viewpoint will return to the previous camera location.



PLAY / PAUSE

This loads and immediately pauses the replay. Select the play icon and hit  to start the replay running. If you hit  during a replay while it is playing, you will be returned to the icon set. Play is used to reach any particular point of interest or action sequence that you want to edit.



AUTO DIRECTOR

Hit the Auto Director icon and the Film Director will run the replay in full, and dynamically switch cameras for you. This is a quick and easy way to not only watch your replays but also a useful tool for learning the finer details and functions of the Film Director. You can interrupt these replays at any time and begin editing them yourself.



FAST FORWARD

When you hit fast forward the replay will freeze while it seeks the desired position or next camera change. You will continue to hear the game running but you will temporarily lose the picture. Hit ⊗ again to return to the replay, in pause mode.



FRAME ADVANCE

Tap the ⊗ button to advance the replay one frame at a time. Essential for when you need to find the exact moment you want to focus on in the replay. Hold down the ⊗ button to advance at the normal speed.



REWIND TO THE BEGINNING

Selecting this icon will instantly rewind the replay back to the start by re-starting your replay. Don't worry about your camera changes and edits, they will remain the same after the restart.

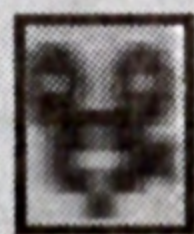

ADD CAMERA

Selecting this icon opens up a submenu with different types of cameras for you to choose from. Camera types that can be adjusted or modified will have another submenu extending horizontally off of their icon. Each added camera will be effective at the point at which you stopped the replay, represented by the black marker.

THESE ARE THE DIFFERENT TYPES OF CAMERAS YOU CAN ADD:



IN CAR

This camera changes the viewpoint to an in-car shot from either your car or any pursuing vehicles.



CHASE CAMERA

This chase cam will chase the car at the angle and position set below.



MOVE CAMERA

This camera defaults to focus on your car as the point of interest. Use the directional pad to move the camera towards the car (up) away from the car (down), around the car clockwise and counterclockwise (left and right), higher (L1), or lower (L2). Holding R1 down while pressing these keys will double their movement speed.

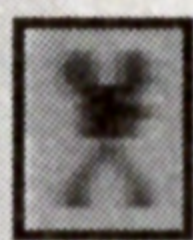

TRIPOD CAMERA

A tripod camera is a fixed, stationary camera, which will focus on any specified action point or vehicle of your choice.



MOVE CAMERA

Use the same controls listed above (Move Camera) to move the camera towards, away from or around the scene. It will default to focussing on the car.



LOCK TO CAR

Select this icon and the camera will focus on and follow (from its stationary position) the car's movement.

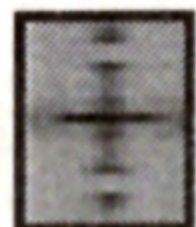

ROTATE

Move the camera to focus on any specified place of interest.



ZOOM

You can zoom in or out of the shot only if you are aiming the camera at the car. Once the replay is running you'll notice that this camera zooms and focuses on the lead car in accordance with its position, relative to the static camera.



OK

You must hit OK to implement any and all changes you have made in all the menus.



CHANGE CAMERA

Edit Camera will change the camera type that the current replay frame has paused / stopped. This is indicated by the black marker at the center of the colored bar.



IN CAR

Change camera type that black marker is currently on to In-Car.



YOU OR PURSUER

Cycle through the perspectives of any vehicles giving chase by selecting this icon and pressing \otimes . When you find the car that you want the camera fixed to, select the "In Car" icon again. Remember to select OK from the bottom of the sub-menu to make these changes effective.



CHASE CAMERA

Change camera type that black marker is currently on to Chase Camera.



TRIPOD CAMERA

Change camera type that black marker is currently on to Tripod camera.

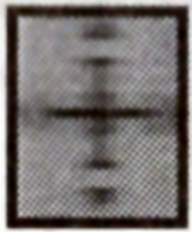

MOVE CAMERA

Use the same controls listed above (Move Camera) to move the camera towards, away from or around the scene. It will default to focussing on the car.

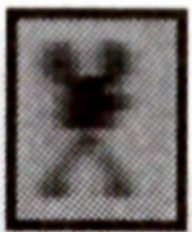

LOCK TO CAR

Select this icon and the camera will focus on and follow (from its stationary position) the car's movement.



ROTATE

Move the camera to focus on any specified place of interest.



MOVE CAMERA START

Move the start position of the camera the black marker is currently on forwards and backwards in time using the directional pad left and right.



DELETE CAMERA POSITION

Delete the camera that the black marker is currently on.



OK

You must hit OK to confirm any and all changes.



SAVE REPLAY

Once you are happy with your replay editing and changes you can save your work to memory card. You can save your progress at any stage during the editing sequence and return to complete your "movie" at a later date.



OK

Selecting OK will exit the Film Director; you will be prompted to save your replay if you have not already saved it. This will exit the Film Director and take you back to the main menu. If you want to exit quickly, save your replay first.

Technical Support (U.S. & Canada)

Assistance Via World Wide Web

Get up-to-the-minute technical information at the GT Interactive Software web-site, at: <http://www.gtisonline.com>, twenty-four hours a day, seven days a week. Through this site you'll have access to our **FAQ** documents, (Frequently Asked Questions) which contain our latest product information. You'll have access to our **Hints/Cheat Codes** area where you can pick up some tips if they're available, and an **E-Mail** area where you can leave us your tech support problems and questions if you do not find your answers within the **FAQ**.

Help Via Telephone/Fax Or Mail

For phone assistance, call GT Interactive Software's **Tech Support** at **425-398-3074**. We have an **Interactive Voice Response** and **Faxback** system that is available twenty-four hours a day, seven days a week. This automated support which will include information from our FAQ documents such as gameplay tips, information on Control Keys, possible cheat code combination keys, instructions for finding secret screens and/or additional game levels if these type items exist and are made available for this particular product. If you should need live support, we are available Monday through Friday, 7:30 AM until 7:30 PM (PST). Please note that live Tech Support may be closed on major holidays. You may also fax in your Technical Support questions or problems to: **(425) 806-0480**, or write in to the address below.

Product Return Procedures In The United States & Canada

If you encounter what may be determined to be a defective product medium issue such as your game freezing at the beginning or during gameplay, no display, etc., you must call our technicians at **425-398-3074**. If they determine that you will need to forward materials directly to us, please include a brief letter explaining what is enclosed and why. Make sure you include the Return Merchandise Authorization Number (RMA#) supplied you by the technician and your telephone number in case we need to call you.

Any materials not containing this RMA# will be returned to you unprocessed. Your mail should be sent to the following address:

GT Interactive Software
13110 NE 177th Place
Suite # B101, Box180
Woodinville, WA 98072-9965
Attn: Technical Support
RMA#: (include your RMA# here)

Technical Support (Europe)

Help Via Telephone In Europe

Technical Assistance: English speaking customers call **01923 209145**

Assistance Technique: Remarque: Notre service de soutien technique se trouve en Angleterre. Clients francophones appelez le **00 44 1923 209148**

Technischer Kundendienst: Beachten Sie bitte dass sich unser technischer Kundendienst in England befindet. Den deutschsprachigen Kundendienst erreichen Sie unter folgender Nummer: **00 44 1923 209151**

This program is protected by United States federal and international copyright laws.
All trademarks mentioned in this manual are the property of their respective owners.

GT CREDITS

Producer Pete Hawley
Director of Marketing Tony Kee
Product Manager Chris Mollo
Director of Communications Dan Harnett
Sr. Comminucations Manager Lance Seymour
Director of Creative Services Leslie Mills
Creative Director Vic Merritt
Production Coordinator Liz Fierro
Sr. Graphic Designer Lesley Zinn
Graphic Artist/Production Jill Pomper
Director of Product Development Services Mary Steer
QA Manager Steve Knopf
Lead Tester Patrick McNeil
Testers
Joshua Fassbinder, Tomasi Akimeta, Jr., Paul Ashby, Darin Cottle, Scott "Cubie" Donaldson, Chris Dunn, Arlo Evans, Josh Galloway, Yume Gregersen, Aaron Harris, Adam Harris, Randy Jones, Jon Marquette, Brandon Montrone, Keith Moran, Joe Orr, AJ Pardia, Tyler Pendleton, Doug Price, Mara'D Smith, Mike Snow

Localization Mark Carter
Manual Editor Pete Witcher

REFLECTIONS CREDITS

Game Concept & Design
Martin Edmondson
Programmers
Derrick Owens, Tony Oakden
Christopher Phillips, Will Musson
James Fowlston, Jeanette Phillips
PC Programmers
Lead
Nathan Whitaker, (More to come.)
Wayne Coles, Russell Lazzari
Steve Burrows
Artists
David Oxford, Andrew Sharrat
Mick McCallion, Carl Jackson
Daniel Oxford Douglas Kalberg
Steven Adams, Christopher Willacy
Andrew Bales, David Oxford Jnr
Aidan Wilson, Jack Couvela, Phil Baxter
3D Artists
Simon McKeown, Shaun Stephenson
Marcus Hardy, Marcel Simons
Stuart Dobbs, Mission Scripting
Tony Roberts, Andreas Tawn
Project Manager
Gareth Edmondson, Additional Work
Mark Sample, Matthew Gibson, Mark Terry
Guillermo Perez Laurrauri, David Demeret

NOTES

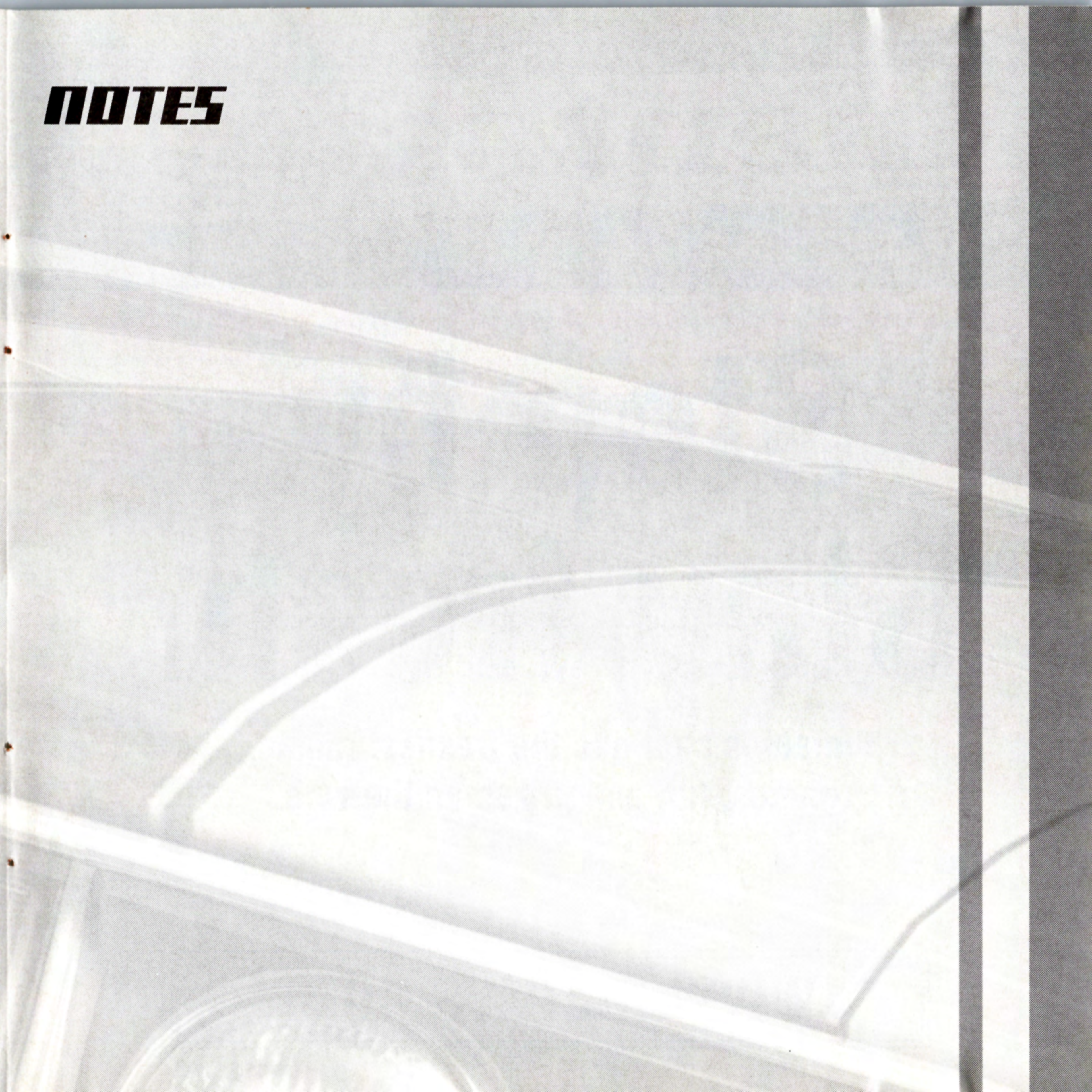



Stop by. Stay fresh.

mentos.com has the freshest music,
games, fun and prizes on the web.

www.mentos.com



Sunglass Hut

I N T E R N A T I O N A L



Watch Station



Gotta have a look.



1-800-SUNGLAS
www.sunglasshut.com

Imagine...

 A SuperStar
in
your house!

Enter to win a
visit from a real
 Superstar!

Go to www.castrolusa.com for details.

No purchase necessary to enter. Void where prohibited.
© 1999 Titan Sports, Inc. All rights reserved.



DRIVE HARD.TM

END-USER LICENSE AGREEMENT

PLEASE READ CAREFULLY. BY USING OR INSTALLING THIS SOFTWARE, OR BY PLACING OR COPYING THIS SOFTWARE ON YOUR COMPUTER HARDWARE, COMPUTER RAM OR OTHER STORAGE MEDIUM, YOU ARE AGREEING TO BE BOUND BY THE TERMS OF THIS LICENSE. IF YOU DO NOT AGREE TO THESE TERMS, PROMPTLY RETURN THE PRODUCT IN ITS PACKAGING TO THE PLACE WHERE YOU OBTAINED IT.

1. License. The software accompanying this license (the "Software") and the related documentation are licensed to you by us and are subject to this license. If the Software is configured for loading onto a hard drive, you may so load the Software only onto the hard drive of a single computer and run the Software off only that hard drive. You may not delete the copyright notices or any other proprietary legends on the original copy of the Software. If there is an editor incorporated into the Software, this license is also subject to Section 8 below. You agree that the Software will not be shipped, transferred or exported into any country in violation of the U.S. Export Administration Act (or any other law governing such matters) by you or anyone at your direction and that you will not utilize and will not authorize anyone to utilize, in any other manner, the Software in violation of any applicable law. The Software may not be downloaded or otherwise exported or reexported into (or to a national or resident of) any country to which the U.S. has embargoed goods or to anyone or into any country who/which are prohibited by applicable law, from receiving such property.
2. Restrictions. The Software contains copyrighted material, trade secrets and other proprietary material. You may not decompile, modify reverse engineer, publicly display, prepare derivative works based on the Software (except as permitted in Section 8, below), disassemble or otherwise reproduce the Software. You may not rent, sell, lease, sublicense or distribute the Software. You may not offer the Software on a pay-per-play basis or otherwise commercially exploit the Software or use the Software for any commercial purpose. You may not electronically transmit the Software from one computer to another or over a network.
3. Termination. This license is effective until terminated. You may terminate this license at any time by destroying the Software and related documentation. This license will terminate immediately without notice from us if you fail to comply with any provision of this license. Upon termination, you must destroy the Software and related documentation.
4. Disclaimer of Warranty on Software. You are aware and agree that use of the Software and the media on which it is recorded is at your sole risk. The Software, related documentation and the media are provided "AS IS". Unless otherwise provided by applicable law, GT Interactive Software Corp. ("GT") warrants to the original purchaser of this product that the Software storage medium will be free from defects in material and workmanship under normal use for ninety (90) days from the date of purchase. This warranty is void if the defect has arisen through accident, abuse, neglect or misapplication. GT EXPRESSLY DISCLAIMS ALL OTHER WARRANTIES, EXPRESS OR IMPLIED, INCLUDING BUT NOT LIMITED TO, THE IMPLIED WARRANTIES OF MERCHANTABILITY AND FITNESS FOR A PARTICULAR PURPOSE. WE DO NOT WARRANT THAT THE FUNCTIONS CONTAINED IN THE SOFTWARE WILL MEET YOUR REQUIREMENTS, NO ORAL OR WRITTEN INFORMATION OR ADVICE GIVEN BY US OR ANY OF OUR AUTHORIZED REPRESENTATIVES SHALL CREATE A WARRANTY OR IN ANY WAY INCREASE THE SCOPE OF THIS WARRANTY. SOME JURISDICTIONS DO NOT ALLOW THE EXCLUSION OF IMPLIED WARRANTIES, SO THE ABOVE EXCLUSIONS MAY NOT APPLY TO YOU.
5. Limitation of Liability. UNDER NO CIRCUMSTANCES, INCLUDING NEGLIGENCE, SHALL GT OR ITS OFFICERS, EMPLOYEES, DIRECTORS, AGENTS, LICENSEES, SUBLICENSEE OR ASSIGNS BE LIABLE FOR ANY INCIDENTAL, SPECIAL OR CONSEQUENTIAL DAMAGES THAT RESULT FROM THE USE OR INABILITY TO USE THE SOFTWARE OR RELATED DOCUMENTATION, EVEN IF SUCH PARTIES HAVE BEEN ADVISED OF THE POSSIBILITY OF THOSE DAMAGES. SOME JURISDICTIONS DO NOT ALLOW THE LIMITATION OR EXCLUSION OF LIABILITY FOR INCIDENTAL OR CONSEQUENTIAL DAMAGES SO THE ABOVE LIMITATION OR EXCLUSION MAY NOT APPLY TO YOU. In no event shall our total liability to you for all damages, losses, and causes of action (whether in contract, tort or otherwise) exceed the amount paid by you for the Software.
6. Controlling Law and Severability. This license shall be governed by and construed in accordance with the laws of the State of New York, USA. Exclusive venue for all litigation shall be in New York, New York. If any provision of this license is unenforceable, the rest of it shall remain in effect.
7. Complete Agreement. This license constitutes the entire agreement between the parties with respect to the use of the Software and the related documentation.
8. Editor and End-user Variations.
 - (a) The Software may include an "Editor". An "Editor" is a feature which allows you to modify the Software or to construct new variations for use with it. These modifications and variations can be both playable and non-playable. An Editor includes its associated tools and utilities. An Editor is NOT shareware. You may not freely distribute it to any BBS, CD, floppy or any other media. You may not sell it or repackage it for sale.
 - (b) Using the Editor, you may create modifications or enhancements to the Software, including the construction of new levels (collectively referred to as "Variations"), subject to the following restrictions:
 - i. Your Variations must only work with the full, registered copy of the Software, not independently or with any other software.
 - ii. Your Variations must not contain modifications to any executable file.
 - iii. Your Variations must not contain any libelous, defamatory, or other illegal material, material that is scandalous or invades the rights of privacy or publicity of any third party, or contains any trademarks, copyright-protected work, or other recognizable property of third parties.
 - iv. At least once in every online description and with reasonable duration on the opening screen, your Variations must prominently identify (i) the names and email addresses of its creators, and (ii) the words "THIS LEVEL IS NOT MADE BY OR SUPPORTED BY GT Interactive Software Corp., The WizardWorks Group, Inc., or any of such parties affiliates and subsidiaries."
 - v. Your Variations must be distributed solely for free. Neither you nor any other person or party may sell them to anyone, commercially exploit them in any way, or charge anyone for using them. You may exchange them at no charge among other end-users.
 - vi. By distributing or permitting the distribution of any of your Variations, you hereby grant back to GT an irrevocable, worldwide, royalty-free right to use and distribute them by any means.
 - vii. The prohibitions and restrictions in this section apply to anyone in possession of the Software or any of your Variations.
9. Copyright. The Software and all copyrights, trademarks and all other conceivable intellectual property rights related to the Software are owned by GT or its licensors and are protected by United States copyrights laws, international treaty provisions and all applicable law, such as the Lanham Act. You must treat the Software like any other copyrighted material, as required by 17 U.S.C. section 101 et seq. and other applicable law. You agree that you are receiving a copy of the Software by license only and not by sale and that the "first sale" doctrine of 17 U.S.C. section 109 does not apply to your receipt or use of the Software.

Please do not make unauthorized copies. The program you've purchase was produced through the efforts of many people who earn their livelihood from its lawful use. Don't make copies for others who have not paid for the right to use it. To report copyright violations to the Software Publishers Association, call 1-800-388-PIR8 or write:

Software Publishers Association, 1101 Connecticut Ave., Suite 901, NW, Washington, DC 20036

This program is protected by United States federal and international copyright laws.
All trademarks mentioned in this manual are the property of their respective owners.
YOU MAY NOT DISTRIBUTE THIS VERSION OF THE SOFTWARE.

Need a hint?

1-900-CALL-2GT

1-900-225-5248

(95¢ per minute. \$1.95 for fax back maps.)

must be 18 years or older, or have parent's permission
to call. touch tone phones only.



Driver © 1999 GT Interactive Software Corp. All Rights Reserved. Created by Reflections Interactive Limited, a GT Interactive Software Corp. studio. Published & distributed by GT Interactive Software Corp. Reflections and the Reflections logo are trademarks of Reflections Interactive Limited. GT is a trademark and the GT logo is a registered trademark of GT Interactive Software Corp. All other trademarks are the property of their respective companies.

Licensed by Sony Computer Entertainment America for use with the PlayStation game console. PlayStation and the PlayStation logos are registered trademarks of Sony Computer Entertainment Inc. The ratings icon is a trademark of the Interactive Digital Software Association. Manufactured and printed in the U.S.A. THIS SOFTWARE IS COMPATIBLE WITH PLAYSTATION GAME CONSOLES WITH THE NTSC U/C DESIGNATION. U.S. AND FOREIGN PATENTS PENDING.

